

CATÁLOGO

Modificado en el 15 de agosto, 2021

RIIFO Mexico, S. de R.L. de C.V.

Oficina 25-107, Avenida Adolfo Lopez Mateos
Norte 95, Italia Providencia Guadalajara, Jalisco,
44648, Mexico

mx.info@riifo.com

INDICE

03 Acerca De RIIFO

05 Innovación

05 Capacidad

05 Instalaciones

05 Producción

06 Certificaciones
RIIFO

06 Miembro Honorario

06 Sistemas De Tubería

08 PROYECTOS
RIIFO

14 Sistema De Tubería
PPR Bicapa

14 Introducción

14 Aplicaciones

14 Segmentos

14 Datos técnicos

14 Ventajas

15 Estructura De Anclaje
De Las Roscas En Las
Conexiones

16 Tubería De
Flujo Mayor

17 Termofusión

17 Conexiones Homogéneas
Confiables

17 Conexión De Rosca De Metal

19 Especificaciones
De Producto

35 Instalación

35 Válvulas / Conexiones

36 Medidas de Protección

36 Presión de trabajo
permitida (bar)

36 Anexo: Tabla de referencia
para Termofusión



ACERCA DE RIIFO

RIIFO es una empresa líder multinacional que brinda soluciones integrales de tuberías para los sectores residencial, comercial, agrícola, industrial y de servicios. Reinventándose de manera incansable desde 1996, cuenta con más de 8 mil empleados, 70 sucursales y filiales y 300 mil distribuidores, prestando servicio a clientes en más de 100 países y regiones.

Con una cadena de valor integrada, que inicia desde la investigación y desarrollo hasta la fabricación y la distribución a través de diferentes canales de venta. Nos esforzamos por cumplir nuestra misión de ofrecer excelentes productos y servicios relacionados al mercado de la tubería.

8,000
Empleados

300,000
Distribuidores a nivel mundial

70
Sucursales y subsidiarias

100+
Sirviendo a más de 100 países y regiones



INNOVACIÓN

Convencidos de que la innovación es la clave para ir más allá de lo ordinario, RIIFO ha desarrollado dos laboratorios de clase mundial reconocidos y certificados por el Servicio de Acreditación Nacional China para Evaluación de Conformidad "CNAS" (China National Accreditation Service for Conformity Assessment) así como el programa de aseguramiento de calidad total para empresas mundiales "Intertek Satellite". A través de más de 600 ingenieros en innovación, no se ha escatimado esfuerzo para desafiar los límites industriales, consiguiendo así 923 patentes y 20 premios de tecnología.

Esta pasión innovadora se ha traducido de manera perfecta en productos y servicios de la más alta calidad, nos esforzamos en ofrecer soluciones ideales de tubería para todos.



CAPACIDAD

Nuestras líneas productivas están completamente automatizadas y cuentan con los más estrictos y exhaustivos controles y sistemas de administración para controlar tan importantes resultados

Instalaciones

10

Bases de producción global

5,200+

Personal de producción

200

Hectáreas de área total

4,000+

Líneas de producción automatizadas

Produccion

Capacidad de Producción

- Tubería: **3.2 billones** metros/año
- Conexiones: **1.3 billones** piezas/año

Capacidad de almacenamiento

- **1,735,000 m³** ≈ 61,950 TEU (Contenedores de 20 pies)

CERTIFICACIONES RIIFO

RIIFO se apega al concepto de prioridad a la calidad, todos sus productos están sujetos a controles estrictos de calidad bajo esquemas de excelencia en manufactura. Al momento cuenta con más de 50 certificados de calidad tales como,

- NSF (certificación de estándares de salud pública, USA)
- DVGW (certificación para productos para agua y gas, Alemania)
- AENOR (normalización y certificación de calidad para empresas, España)
- WRAS (certificación para conexiones contra fugas, residuos, buen funcionamiento, contaminación, UK)
- WATERMARK (certificación en salud y seguridad, Australia)

Estos certificados mundiales validan nuestro conocimiento técnico y de calidad para proporcionar a los consumidores garantías hasta por 25 años en nuestros productos en diferentes países*, respaldados por una empresa de seguros internacional

* Cumple con el estandar: NMX-E-226/2-CNCP

Miembro Honorario



Sistemas De Tuberia



USA



GERMANY



FRANCE



FRANCE



SPAIN



UK



NETHERLAND



FINLAND



EU



AUSTRALIA



AUSTRALIA



AUSTRALIA

PROYECTOS RIIFO



PROYECTOS RIIFO



Lima, Peru

Project: Edificio Multifamiliar
Sucre 260
Type: Residential
Year: 2017
Product: PPR Plumbing System



Lima, Peru

Project: Edificio Multifamiliar
Jacinto Lara
Type: Residential
Year: 2017
Product: PPR Plumbing System

PROYECTOS RIIFO

Nakhonsawon, Thailand

Project: 42C Hotel
Type: Hotels
Year: 2019
Product: PPR Plumbing System



Bali, Indonesia
Project: FOX HARRIS Jimbaran Beach
Type: Hotels
Year: 2016
Product: PPR Plumbing System

Samui Island, Thailand

Project: Sofitel So Samui
Type: Hotels
Year: 2019
Product: PPR Plumbing System

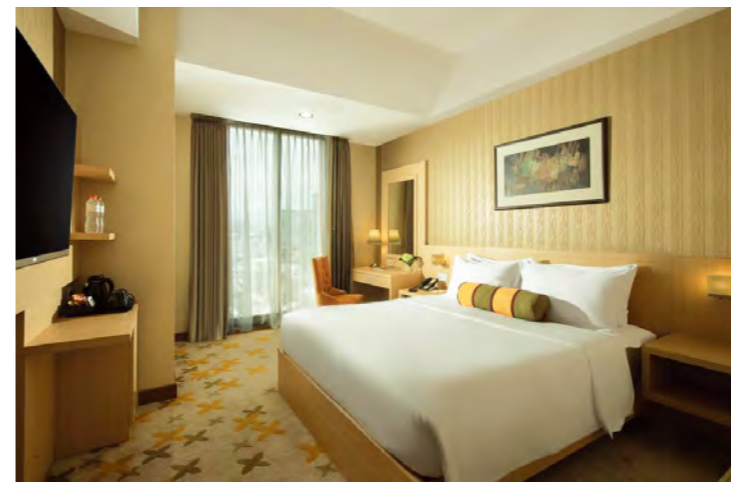

Semarang, Indonesia

Project: Hotel Chanti
Type: Hotels
Year: 2017
Product: PPR Plumbing System



Chon Buri, Thailand

Project: The Hill Pattaya
Type: Hotels
Year: 2019
Product: PPR Plumbing System

PROYECTOS RIIFO



Beijing, China

Project: Capital International Airport (T3)
Type: Public Buildings
Year: 2008
Product: PPR plumbing system



Cangzhou, China

Project: Cangzhou Museum
Type: Public Buildings
Year: 2010
Product: PPR plumbing system

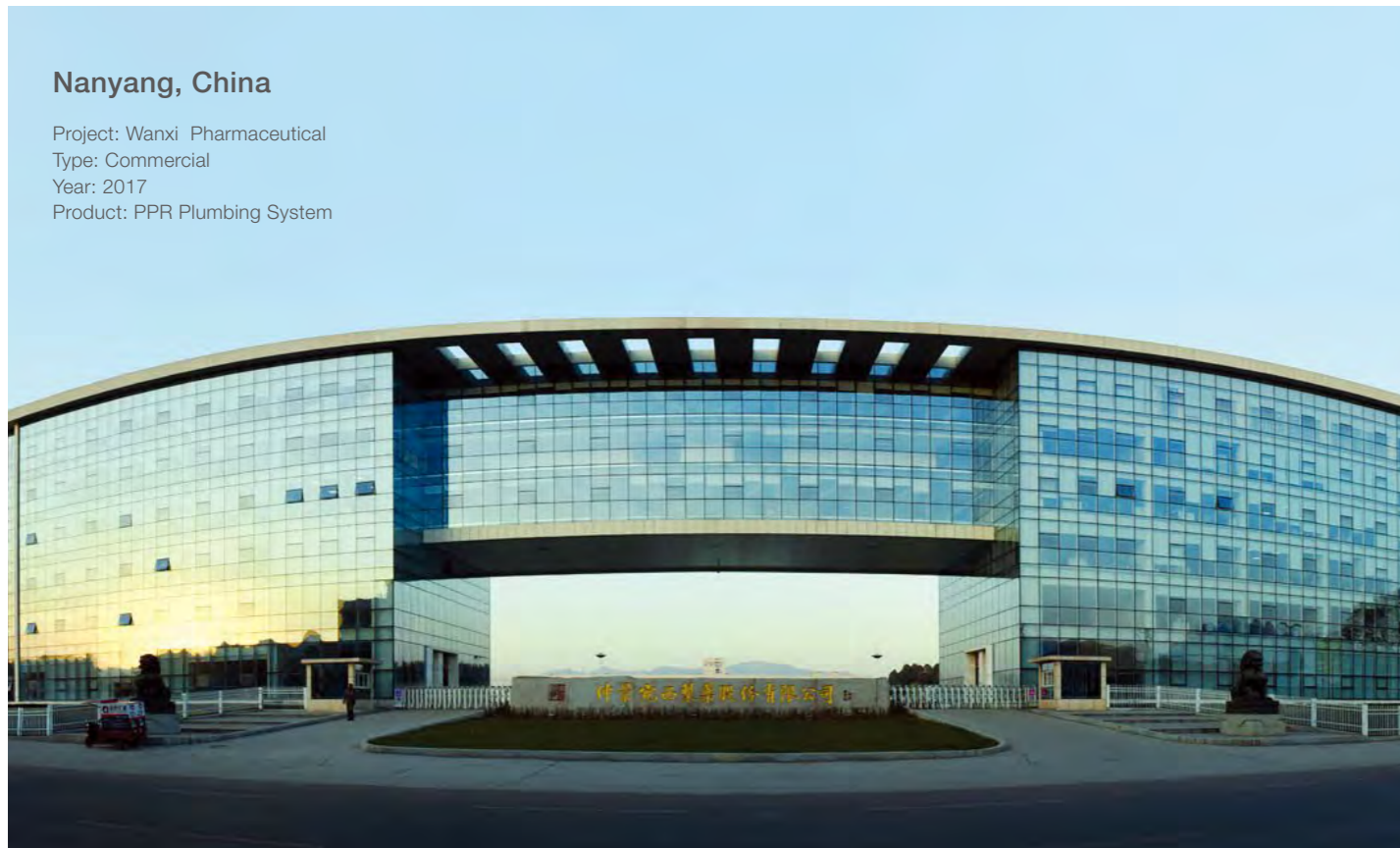

Nanyang, China

Project: Wanxi Pharmaceutical
Type: Commercial
Year: 2017
Product: PPR Plumbing System



Bekasi, Indonesia

Project: Chadstone Sales Gallery
Cikarang
Type: Residential
Year: 2018
Product: PPR Plumbing System



GORO, Ethiopia

Project: Sunrise Luxury Apartment
Type: Residential
Year: 2017
Product: PPR Plumbing System+PVC

SISTEMA DE TUBERIA PPR BICAPA

Introducción

El Sistema de tubería PPR doble capa de RIIFO esta fabricado con la formula mas avanzada de Polipropileno Copolímero Random virgen de alta calidad, no es toxico, no fabricado con resinas recicladas por lo que es muy confiable para conducción de agua potable recomendado para segmentos residencial, comercial e industrial.

Gracias a su capa exterior color verde, y a su capa interior blanca previene de manera eficiente el paso del oxígeno y luz, por lo que no formara bacterias, manteniendo así agua limpia siempre.

Es así como RIIFO continúa desarrollando nuevos productos con el paso de los años, como la Serie de Flujo Mayor, ofreciendo experiencia más higiénica y segura en las tuberías para los clientes en el mundo.

Aplicaciones

- Para agua fría y caliente
- Para uso en aire acondicionado
- Para sistemas de calentamiento solar
- Para sistemas de calentamiento de agua

Segmentos

- Departamentos, condominios y vivienda publica.
- Centros comerciales y edificios públicos
- Plantas industriales con manejo de químicos, procesadoras de alimento.
- Hospitales.
- Escuelas, laboratorios y tratamiento de aguas residuales.
- Hoteles y resorts.

Datos técnicos

Temperatura de trabajo: 3°C hasta 95°C
Presión de trabajo: 20.2 kg/cm² (20 bar)
Vida útil: 50 años

Ventajas

Ventajas De La Tuberia PPR

- | | |
|--|---|
|  Resistente a la corrosión |  Extraordinaria propiedad de aislamiento del calor y el sonido |
|  Ligero |  Tubo interior liso |
|  Higiénico no toxico |  Conexiones compatibles |
|  Alta resistencia a radiación ultravioleta. |  Vida útil mayor a 50 años |

Ventajas De Las Conexiones PPR

- | | |
|--|--|
|  Diseño de ángulos largos para mayor eficiencia |  Diseño único de inserción de ranura de cola de Milano |
|  Superficie de acabado pulido anti-oxidación |  Nuevos sistemas de diseño para mantener eficiencia de abasto de agua, como los codos U |



ESTRUCTURA DE ANCLAJE DE LAS ROSCAS EN LAS CONEXIONES



1 Estructura Incrustada - RIIFO

Asegura cero fugas, excelente desempeño de hermeticidad por su forma especial incrustada en la base de la conexión.



2 Estructura común sobrepuesta - Otras marcas

Esta sección en conexiones de PPR simples, tienden a deformarse con la fluctuación de la temperatura y se generan las fugas.



TUBERIA DE FLUJO MAYOR

Los productos RIIFO de la serie de flujo mayor fabricados de polipropileno mejorado, superan al doble que los actuales en el mercado.

DERIVACION "Y"

- Incrementa del flujo del agua en un 50%
- Diseño resistente y soporte incluido.
- Diagrama de Ensamble que muestra dirección de flujo.



CODO DE ARCO LARGO

- Gracias a su diseño alargado y curvo permite que el flujo del agua se disperse y circule por todo el cuerpo del codo absorbiendo y eliminando hasta en un 50% la presión ejercida en las uniones lo cual genera fugas y daño a la tubería.



ENSAMBLE REGADERA DOBLE CODO "U"

- El nuevo diseño con nivelador incluido, se instala perfectamente en sistemas de flujo eficientes, usando el método de recirculación para agua fría y caliente.
- Diseño mejorado que permite un mejor flujo.
- Instalación más sencilla y adaptable.



VÁLVULA DE COMPUERTA

- Diámetro de paso completo, incrementando el flujo al 200%
- Triple sello O-ring de nitrilo, evita fugas.
- Vástago de latón de alta calidad más resistente.



TERMOFUSION

Conexiones Homogeneas Confiables

La termofusion homogénea provee una conexión confiable, fuerte y con propiedades selladoras entre las conexiones y las tuberías.

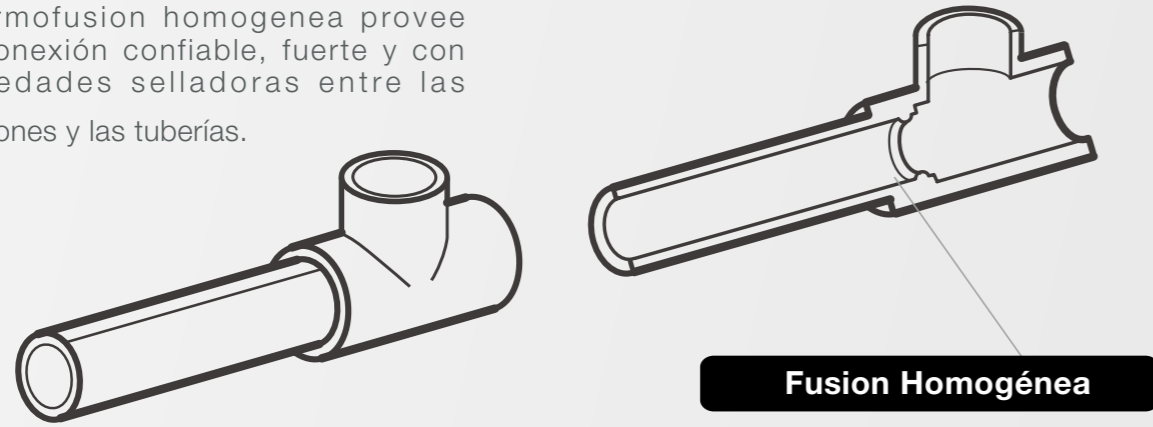

Conexión De Rosca De Metal

RIIFO también ofrece conexiones rosca de metal para garantizar la conversión de la conexión en diferentes escenarios

Las conexiones RIIFO tienen una estructura única incrustada entre la conexión de PPR y el inserto de metal la cual elimina el riesgo de fugas causados por huecos generados por el comportamiento de la conducción térmica del plástico y el latón. RIIFO mantiene la patente exclusiva de esta estructura incrustada de sus conexiones

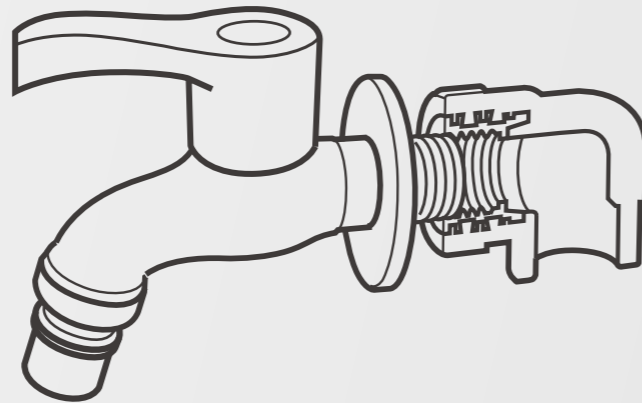

ROSCA CON ESTRUCTURA INCRUSTADA:

Evita el riesgo de fuga causado por expansiones térmicas

36 PUNTOS DE SUJECION:

Ajuste entre el inserto de metal y la pieza de plástico.

ANILLO DE SEGURIDAD DE TOPE:

Evita el sobre roscado entre las conexiones



ESPECIFICACIONES



ESPECIFICACIONES DE PRODUCTO

Tubería PPR Bicapa

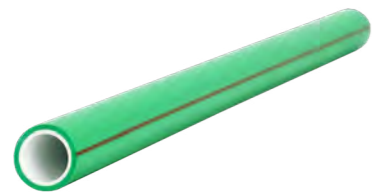

Modelo	Medida en Pulgadas	Empaque	Color
041389	1/2"	160	Green/White
041390	3/4"	128	Green/White
041391	1"	64	Green/White
041392	1 1/4"	48	Green/White
041393	1 1/2"	28	Green/White
041394	2"	20	Green/White
041405	2 1/2"	16	Green/White
041406	3"	12	Green/White
041407	4"	8	Green/White

Cople

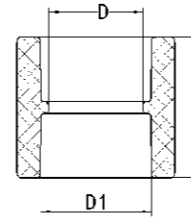

Modelo	Medida en Pulgadas	Empaque	D	D1	L
041412	1/2"	135	16	19.2	34.5
041413	3/4"	60	20	24.1	39
041414	1"	40	26	31.1	44
041415	1 1/4"	1	33	39	48
041416	1 1/2"	1	43	49	55
041417	2"	1	55	61.9	64
041418	2 1/2"	1	69.7	73.6	70
041419	3"	1	84.3	88.3	80
041420	4"	1	103.3	107.9	94

Reducción

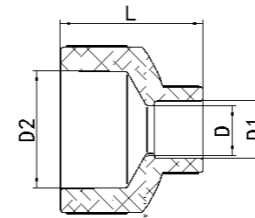

Modelo	Medida en Pulgadas	Empaque	D	D1	D2	L
041421	3/4" x 1/2"	90	16	19.2	24.1	39
041422	1" x 1/2"	60	16	19.2	31.1	43
041423	1" x 3/4"	50	20	24.1	31.1	44
041424	1 1/4" x 1/2"	1	16	19.2	39	47
041425	1 1/4" x 3/4"	1	20	24.1	39	48
041426	1 1/4" x 1"	1	26	31.1	39	49
041427	1 1/2" x 1/2"	1	16	19.2	49	53.5
041428	1 1/2" x 3/4"	1	20	24.1	49	55
041429	1 1/2" x 1"	1	26	31.1	49	55.5
041430	1 1/2" x 1 1/4"	1	33	39	49	56
041433	2" x 1 1/2"	1	43	49	61.9	64
041435	3" x 1 1/2"	1	46	49	88.3	95
041436	3" x 2"	1	58.8	61.9	88.3	100.5
041439	4" x 2"	1	58.8	61.9	107.9	105.5
041441	4" x 3"	1	84.3	88.3	107.9	114

Tapón

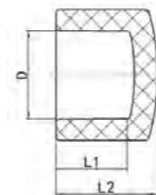

Modelo	Medida en Pulgadas	Empaque	D	L1	L
041442	1/2"	180	20	16	22
041443	3/4"	150	25	18	25
041444	1"	70	32	20	28.5
041445	1 1/4"	1	40	22	32
041446	1 1/2"	1	50	25.5	37
041447	2"	1	63	29.5	44
041448	2 1/2"	1	75	32	46.2
041449	3"	1	90	36	52.8
041450	4"	1	110	42	63

Codo 90°

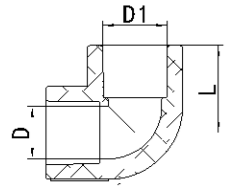

Modelo	Medida en Pulgadas	Empaque	D	D1	L
041451	1/2"	80	16	19.2	26.5
041452	3/4"	50	20	24.1	31
041453	1"	24	26.4	31.1	36.5
041454	1 1/4"	1	33	39	42.5
041455	1 1/2"	1	43	49	51
041456	2"	1	55	61.9	61.5
041457	2 1/2"	1	69.7	73.6	70.7
041458	3"	1	84.3	88.3	82
041459	4"	1	103.3	107.9	97.7

Codo 45°

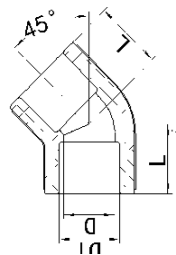

Modelo	Medida en Pulgadas	Empaque	D	D1	L
041460	1/2"	90	16	19.2	21.5
041461	3/4"	60	20	24.1	25
041462	1"	30	26	31.1	29
041463	1 1/4"	1	33	39	32.5
041464	1 1/2"	1	43	49	38.5
041465	2"	1	55	61.9	45
041466	2 1/2"	1	69.7	73.6	51.2
041467	3"	1	84.3	88.3	58.3
041468	4"	1	103.3	107.9	68.3

Codo Reducción 90°

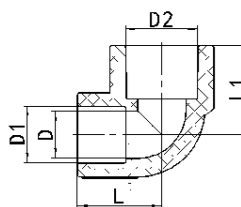

Modelo	Medida en Pulgadas	Empaque	D	D1	D2	L	L1
041469	3/4" x 1/2"	50	16	19.2	24.1	28	30
041470	1" x 1/2"	32	16	19.2	31.1	32	32.5
041471	1" x 3/4"	24	20	24.1	31.1	34	35

Tee

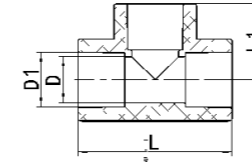

Modelo	Medida en Pulgadas	Empaque	D	D1	L	L1
041472	1/2"	60	16	19.2	53	26.5
041473	3/4"	32	20	24.1	62	31
041474	1"	20	26.5	31.1	73	36.5
041475	1 1/4"	1	33	39	85	42.5
041476	1 1/2"	1	43	49	102	51
041477	2"	1	55	61.9	123	61.5
041478	2 1/2"	1	69.7	73.6	141.3	70.7
041479	3"	1	84.3	88.3	163.9	82
041480	4"	1	103.3	107.9	195.3	97.7

Tee Reducción

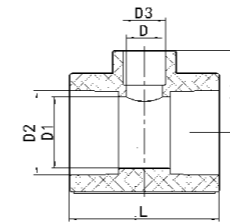

Modelo	Medida en Pulgadas	Empaque	D	D1	D2	D3	L	L1
041482	3/4" x 1/2" x 3/4"	40	16	20	24.1	19.2	57.5	28.5
041483	1" x 1/2" x 1"	20	16	26.5	31.1	19.2	63	32
041484	1" x 3/4" x 1"	20	20	26.5	31.1	24.1	67	34
041485	1 1/4" x 1/2" x 1 1/4"	1	16	33	39	19.2	67	38
041486	1 1/4" x 3/4" x 1 1/4"	1	20	33	39	24.1	71	38
041487	1 1/4" x 1" x 1 1/4"	1	26	33	39	31.1	77	41
041488	1 1/2" x 1/2" x 1 1/2"	1	16	43	49	19.2	75	44
041489	1 1/2" x 3/4" x 1 1/2"	1	20	43	49	24.1	79	44
041490	1 1/2" x 1" x 1 1/2"	1	26	43	49	31.1	85	46
041491	1 1/2" x 1 1/4" x 1 1/2"	1	33	43	49	39	92	48
043462	2" x 1/2" x 2"	1	16	55	61.9	19.2	84	53
041492	2" x 3/4" x 2"	1	20	55	61.9	24.1	88	53
041493	2" x 1" x 2"	1	26	55	61.9	31.1	94	53
041494	2" x 1 1/4" x 2"	1	33	55	61.9	39	101	54
041495	2" x 1 1/2" x 2"	1	43	55	61.9	49	111	58
041496	2 1/2" x 3/4" x 2 1/2"	1	22	69.7	73.6	24.1	93.1	56.7
041497	2 1/2" x 1" x 2 1/2"	1	29	69.7	73.6	31.1	100	57.2
041498	2 1/2" x 1 1/4" x 2 1/2"	1	36	69.7	73.6	39	107.9	59.7
041499	2 1/2" x 1 1/2" x 2 1/2"	1	46	69.7	73.6	49	117.8	64.2
041500	2 1/2" x 2" x 2 1/2"	1	59	69.7	73.6	61.9	130.7	68.2
041501	3" x 1" x 3"	1	26.5	84.3	88.3	31.1	108	66.3
041502	3" x 1 1/4" x 3"	1	36	84.3	88.3	39	115.9	68
041503	3" x 1 1/2" x 3"	1	46	84.3	88.3	49	125.8	71.5
041504	3" x 2" x 3"	1	59	84.3	88.3	61.9	138.7	75.5
041505	3" x 2 1/2" x 3"	1	69.7	84.3	88.3	73.6	149.3	78
041506	4" x 3/4" x 4"	1	20	103.3	107.9	24.1	115	80
041507	4" x 1 1/4" x 4"	1	33	103.3	107.9	39	128	80
041508	4" x 1 1/2" x 4"	1	46	103.3	107.9	49	137.8	81.2
041509	4" x 2" x 4"	1	59	103.3	107.9	61.9	150.7	85.2
045012	4" x 2 1/2" x 4"	1	69.7	103.3	107.9	73.6	161.3	87.7
045013	4" x 3" x 4"	1	84.3	103.3	107.9	88.3	175.9	91.7

Tee Reducción

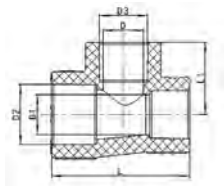

Modelo	Medida en Pulgadas	Empaque	D	D1	D2	D3	L	L1
041481	3/4" x 1/2" x 1/2"	50	16	16	24.1	19.2	55	29

Tee Salida Lateral

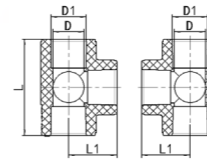

Modelo	Medida en Pulgadas	Empaque	D	D1	L	L1
043465	1/2"	30	17	19.2	53	26.5
043466	3/4"	30	21	24.1	62	31
043467	1"	20	28	31.1	73	36.5

Derivación "Y"

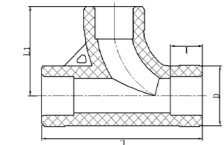

Modelo	Medida en Pulgadas	Empaque	D	D1	D2	L1
043463	1/2"	20	29.4	16	80	44
043464	3/4"	15	36	18	95	52

Curva 90°

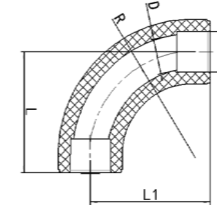

Modelo	Medida en Pulgadas	Empaque	D	D1	R	L	L1
041940	1/2"	20	16.5	19.2	50.2	57	57
041941	3/4"	15	21	24.1	59.7	67	67
041942	1"	10	28	31.1	70.8	79	79

Cruz

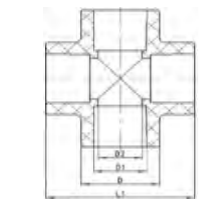

Modelo	Medida en Pulgadas	Empaque	D	D1	D2	L1
045003	1/2"	24	28.4	20	16	54
045004	3/4"	15	34.5	25	20	64
045005	1"	10	26.5	32	43.7	75

Curva Sobrepase Corta

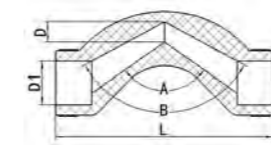

Modelo	Medida en Pulgadas	Empaque	D	D1	R	L	L1
041713	1/2"	30	9	19.2	96	110°	123°
041939	3/4"	24	7.8	24.1	124	116°	131°
043468	1"	10	15.6	31.1	156	126°	139°

Tee Esquinada

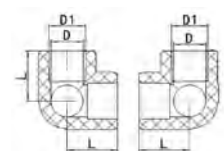

Modelo	Medida en Pulgadas	Empaque	D	D1	L
045000	1/2"	30	17	19.2	26.5
045001	3/4"	30	21	24.1	31
045002	1"	20	28	31.1	36.5

Curva Sobrepase Larga

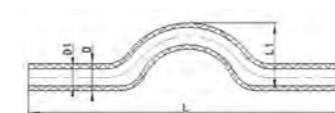

Modelo	Medida en Pulgadas	Empaque	D	D1	L	L1
044995	1/2"	24	20	13.2	360	50
044996	3/4"	1	25	16.6	360	60
044997	1"	1	32	21.2	360	60

Tuerca Union

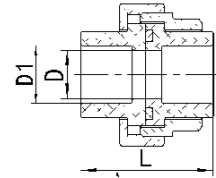

Modelo	Medida en Pulgadas	Empaque	D	D1	L
041510	1/2"	20	16	19.2	41
041511	3/4"	15	20	24.1	45
041512	1"	12	26	31.1	50

Conector Macho

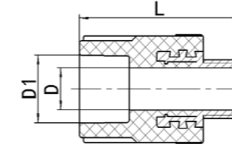

Modelo	Medida en Pulgadas	Empaque	D	D1	L
042860	1/2" x 1/2"M	40	15	19.2	56
042861	1/2" x 3/4"M	30	16	19.2	57
042862	3/4" x 1/2"M	35	15	24.1	59
042863	3/4" x 1"M	15	20	24.1	73
042864	3/4" x 3/4"M	30	20	24.1	60

Tuerca Union Mixta Macho

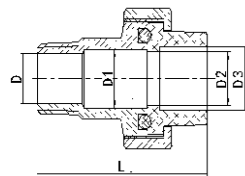

Modelo	Medida en Pulgadas	Empaque	D	D1	D2	D3	L
045426	1/2" x 1/2"M	25	15	21.4	16	19.2	52
045425	3/4" x 1/2"M	25	20	21	20	24.1	55
045427	3/4" x 1"M	20	26	23	20	24.1	57
045428	3/4" x 3/4"M	15	20	22	26	31.1	59.5
045429	1" x 1"M	12	26	28	26	31.1	59.5
045430	1 1/4" x 1 1/4"M	1	34	36	34	39	80
045431	1 1/2" x 1 1/2"M	1	39	42	45	49	88
045432	2" x 2"M	1	50.5	54	57	61.9	103

Conector Hembra

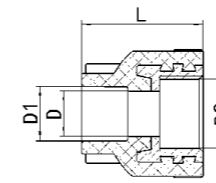

Modelo	Medida en Pulgadas	Empaque	D	D1	D2	L
042865	1/2" x 1/2"F	60	16.4	19.2	19.1	42
042866	1/2" x 3/4"F	40	17	19.2	24.5	42
042867	3/4" x 1/2"F	50	16.4	24.1	19.1	45
042868	3/4" x 3/4"F	30	22	24.1	24.5	45
042869	1" x 1"F	16	22	31.1	24.5	47
042870	1" x 3/4"F	30	26	31.1	30.6	56
042871	1 1/4" x 1 1/4"F	1	33.5	39	39	65
042872	1 1/2" x 1 1/2"F	1	38.5	49	44.9	70
042873	2" x 2"F	1	50	61.9	56.7	81

Tuerca Union Mixta Hembra

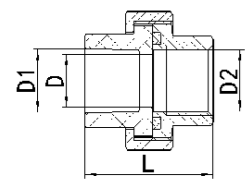

Modelo	Medida en Pulgadas	Empaque	D	D1	D2	L
045433	1/2" x 1/2"F	30	16	19.2	19.1	39
045434	3/4" x 3/4"F	20	20	24.1	24.5	42
045435	1" x 1"F	15	26	31.1	30.1	46
045436	1 1/2" x 1 1/2"F	1	45	49	44.85	58

Codo Oreja Hembra

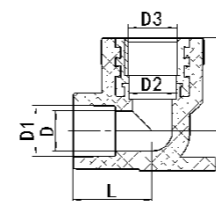

Modelo	Medida en Pulgadas	Empaque	D	D1	D2	D3	L
042874	1/2" x 1/2"F	35	16.4	19.2	16.4	19.1	30

Codo 90° Rosca Macho

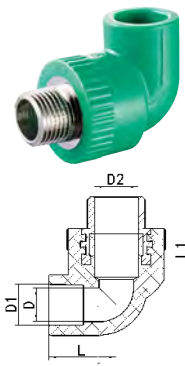

Modelo	Medida en Pulgadas	Empaque	D	D1	D2	L	L1
042875	1/2" x 1/2"M	40	14.8	19.2	15.1	30	49
042876	3/4" x 1/2"M	30	14.8	24.1	15.1	31.5	52
042877	3/4" x 3/4"M	25	19.5	24.1	20	33	54
042878	1" x 1"M	10	19.5	31.1	20	37.5	58
042879	1" x 3/4"M	20	26.07	31.1	26.3	40.5	73

Codo 90° Rosca Hembra

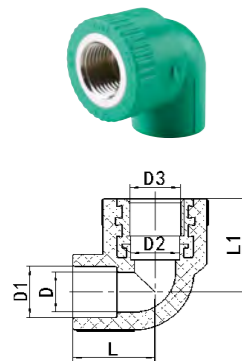

Modelo	Medida en Pulgadas	Empaque	D	D1	D2	D3	L	L1
042880	1/2" x 1/2"F	40	16.4	19.2	16.4	19.1	30	35
042881	3/4" x 1/2"F	30	16.4	24.1	16.4	19.1	31.5	38
042882	3/4" x 3/4"F	25	22	24.1	22	24.5	33	39
042883	1" x 1/2"F	24	22	31.1	22	24.5	37.5	43
042884	1" x 1"F	10	26	31.1	26	30.6	40.5	56
042885	1" x 3/4"F	20	22	31.1	22	24.5	37.5	43

Tee Rosca Central Hembra

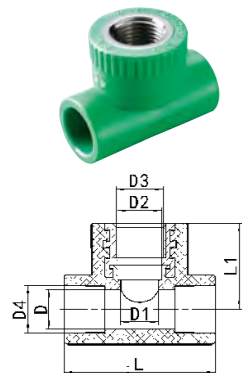

Modelo	Medida en Pulgadas	Empaque	D	D1	D2	D3	D4	L	L1
042886	1/2" x 1/2"F	36	16.4	16.4	19.1	19.1	19.2	60	35
042887	3/4" x 1/2"F	30	20	16.4	16.4	19.1	24.1	63	38
042888	3/4" x 3/4"F	25	20	22	22	24.5	24.1	66	39
042889	1" x 1/2"F	18	26	16.4	16.4	19.1	31.1	68	43
042890	1" x 1"F	10	26	22	22	24.5	31.1	75	43
042891	1" x 3/4"F	12	26.5	26	26	30.6	31.1	81	56

Tee Rosca Central Macho

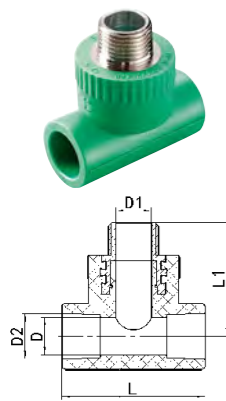

Modelo	Medida en Pulgadas	Empaque	D	D1	D2	L	L1
042892	1/2" x 1/2"M	30	16	15	19.2	60	49
042893	3/4" x 1/2"M	24	20	15	24.1	63	52
042894	3/4" x 3/4"M	20	20	20	24.1	66	54
042895	1" x 1/2"M	15	26	15	31.1	68	57
042896	1" x 3/4"M	15	26	20	31.1	75	58
042897	1" x 1"M	10	26.5	26	31.1	81	73

Cople Hembra Desmontable

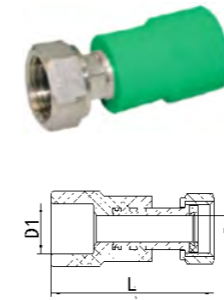

Modelo	Medida en Pulgadas	Empaque	D	D1	L
045437	1/2 x 1/2F	30	9	19.2	61.5

Codo Hembra Desmontable

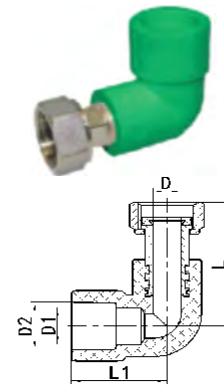

Modelo	Medida en Pulgadas	Empaque	D	D1	D2	L	L1
045438	3/4 x 1/2F	30	9	15	19.2	50.5	34.5

Codo "U" Hembra

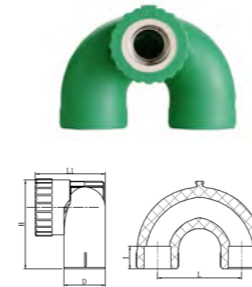

Modelo	Medida en Pulgadas	Empaque	D	I	H	L	L1
045439	1/2" x 1/2"F x 1/2"	20	29.4	16	63	60	50
045440	3/4" x 1/2"F x 3/4"	16	36	18	70	60	55

Ensamble Doble Codo "U" Hembra

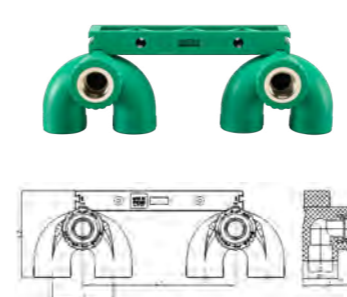

Modelo	Medida en Pulgadas	Empaque	D	D1	L	L1	L2	L3
045441	1/2" x 1/2"F	10	20	29.4	52	150	78	60
045442	3/4" x 1/2"F	8	25	36	55	150	86	60

Ensamble Doble Codo Hembra

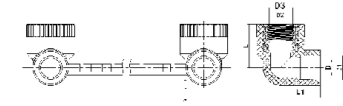

Modelo	Medida en Pulgadas	Empaque	D	D1	D2	D3	L	L1
042898	1/2" x 1/2"F	10	16.4	19.2	16.4	19.1	35	32

Ensamble Doble Tee

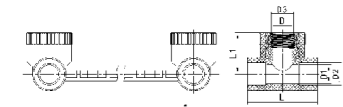

Modelo	Medida en Pulgadas	Empaque	D	D1	D2	D3	L	L1
045443	1/2 x 1/2"F	12	16.4	16.4	19.2	19.1	60	35
045444	3/4 x 1/2"F	12	16.4	20	24.1	24.5	63	38
045445	1/2 x 1/2"F	12	16.4	16.4	19.2	19.1	60	35
045446	3/4 x 1/2"F	12	16.4	20	24.1	24.5	63	38

Valvula Esfera PPR Desmontable

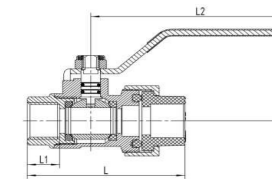

Modelo	Medida en Pulgadas	Empaque	L1	L	H
042048	1/2"	10	102	87.5	52
042049	3/4"	8	102	92.5	56
042050	1"	4	115	108	59
042051	1 1/4"	2	164	129.5	81.5
042052	1 1/2"	1	193	146	95
042053	2"	1	253	171.5	102

Valvula Esfera Rosca Hembra

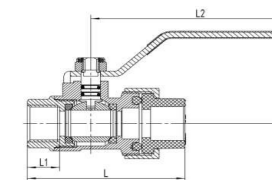

Modelo	Medida en Pulgadas	Empaque	L1	L2	L	H
045416	1/2" x 1/2"F	10	15	102	72.5	52
045418	3/4" x 3/4"F	8	16	102	79	56
045420	1" x 1"F	4	16	115	90.5	59

Valvula Esfera Rosca Macho

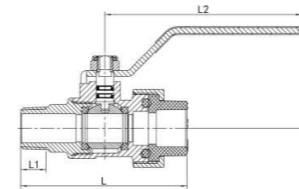

Modelo	Medida en Pulgadas	Empaque	L1	L2	L	H
045415	1/2" x 1/2"M	10	14	102	86.5	52
045417	3/4" x 3/4"M	8	15	102	89	56
045419	1" x 1"M	4	16	115	98.5	59

Valvula Globo

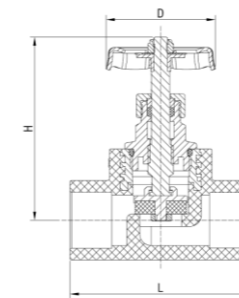

Modelo	Medida en Pulgadas	Empaque	L	H	D
041911	1/2"	12	70	75	50.5
041912	3/4"	12	78	80	60
041913	1"	6	90	91	69
041914	1 1/4"	1	97	100.5	69
041915	1 1/2"	1	116	111.5	78
041916	2"	1	134	129.5	89

Valvula Esfera

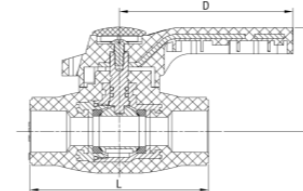

Modelo	Medida en Pulgadas	Empaque	L	H	D
042054	1/2"	15	78	48.5	77
042055	3/4"	10	88	51	77
042056	1"	8	96	55	103
042057	1 1/4"	4	104	60	103
042058	1 1/2"	4	128	77	128
042059	2"	2	148	85	128

Adaptador Para Brida

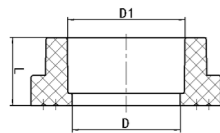

Modelo	Medida en Pulgadas	Empaque	D	D1	L
045037	1 1/4"	1	35	39	29
045038	1 1/2"	1	45	49	32
045039	2"	1	57	61.9	36
042346	2 1/2"	1	69.5	73.6	38
045040	3"	1	84	88.3	46
042347	4"	1	103	107.9	53

Soporte Plastico



Modelo	Medida en Pulgadas	Empaque	D	D1	D2	H
041947	1/2"	180	10	19.5	30	52
041948	3/4"	150	12	24	35	56
041949	1"	100	15	30	44	59

Empaque Para Brida

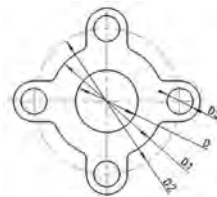

Modelo	Medida en Pulgadas	Empaque	D	D1	D2	D3
045041	1 1/4"	1	43	78	100	18
045042	1 1/2"	1	49	86	110	18
045043	2"	1	61	100	125	18
042344	2 1/2"	1	77	121	145	18
045044	3"	1	89	136	160	18
042345	4"	1	115	162	180	18

Corta Tubo



Modelo	Medida en Pulgadas	Empaque
044118	1/2" - 1"	10

Anillo Adaptador Para Brida

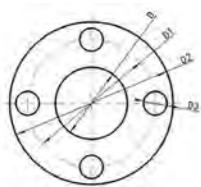

Modelo	Medida en Pulgadas	Empaque	D	D1	D2	D3
045033	1 1/4"	1	56	100	128	18
045034	1 1/2"	1	65	110	138	18
045035	2"	1	86	125	153	18
042342	2 1/2"	1	96	145	173	18
045036	3"	1	121	160	188	18
042343	4"	1	146.5	180	208	18

Corta Tubo



Modelo	Medida en Pulgadas	Empaque
044112	1/2" - 2 1/2"	1

Kit Termofusor



Modelo	Medida en Pulgadas	Empaque
044117	1/2" - 2"	1
044115	2 1/2" - 4"	1
044116	1/2" - 1"	1

Dados M-H



Modelo	Medida en Pulgadas	Empaque
042022	1/2"	1
042023	3/4"	1
015818	1"	1
015819	1 1/4"	1
015820	1 1/2"	1
015821	2"	1
015822	2 1/2"	1
015823	3"	1

Kit Termofusor



Modelo	Medida en Pulgadas	Empaque
038054	1/2" - 6"	1

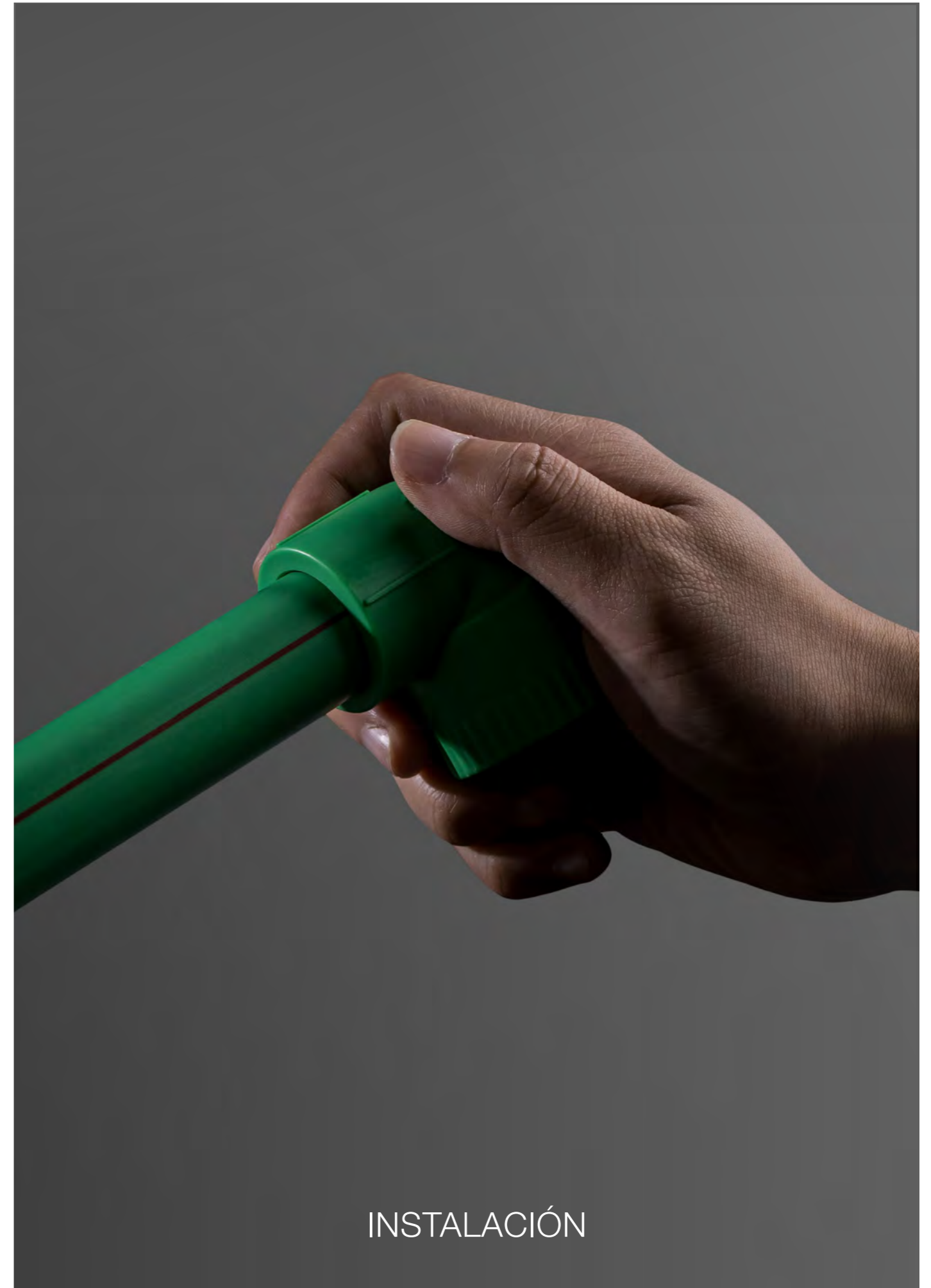

INSTALACIÓN

INSTALACIÓN



Valvulas / Conexiones

PASO 1:

Corte la tubería verticalmente.



PASO 2:

Remueva la rebaba y limpie la superficie rugosa. Marque la profundidad de termofusión.



PASO 3:

Inserte y presione la tubería hasta el marcaje de profundidad así como la conexión de manera simultánea en los dados de la termofusora. Si sobrepasa la posición de profundidad o sobrecalienta la tubería puede encogerse u obstruirse. Revise tiempos de fusión en la tabla anexa



PASO 4:

Cuando el tiempo de termofusión se cumple tome rápidamente la tubería y la conexión de los dados. y unir entre si.



PASO 5:

Mantenga presionadas ambas piezas hasta que el proceso de termofusión se complete.

Anexo: Tabla de referencia para Termofusion

>>

Nota:

Esta tabla aplica a una temperatura ambiente de 20 °C , por debajo de la temperatura extienda el tiempo de calentamiento. Si la temperatura es menor a 5 °C extienda el tiempo de calentamiento incrementando el 50%.

Diametro del tubo y la conexión (mm)	Profundidad mínima del conector (mm)	Tiempo de Calentamiento (s)	Intervalo máximo de unión (s)	Tiempo de Enfriamiento (min)
20	14.0	5	4	2
25	15.0	7	4	2
32	16.5	8	6	4
40	18.0	12	6	4
50	20.0	18	6	4
63	24.0	24	8	6
75	26.0	30	8	8
90	29.0	40	8	8
110	32.5	50	10	8

Presión de trabajo permitida (bar)

>>

Temperatura	Vida de servicio (año)	Presión de trabajo permitida (kg/cm ² / Bar / PSI)		
		Presión de trabajo permitido		
		kg/cm ²	Bar	PSI
20°C	10	21.9	21.5	311.8
	25	21.2	20.8	301.7
	50	20.6	20.2	293.0
30°C	10	18.6	18.2	264.0
	25	17.9	17.6	255.3
	50	17.4	17.1	248.0
40°C	10	15.7	15.4	223.4
	25	15.1	14.8	214.7
	50	14.7	14.4	208.9
50°C	10	13.3	13	188.6
	25	12.7	12.5	181.3
	50	12.3	12.1	175.5
60°C	10	11.1	10.9	158.1
	25	10.7	10.5	152.3
	50	10.3	10.1	146.5
70°C	10	10.1	9.9	143.6
	25	8.1	7.9	114.6
	50	6.8	6.7	97.2
80°C	10	6.5	6.4	92.8
	25	5.2	5.1	74.0
	50	4.4	4.3	62.4
95°C	10	3.6	3.5	50.8
	25	2.9	2.8	40.6
	50	2.3	2.3	33.4

Medidas de Protección

Nota:

Todos los materiales plásticos son atacados por los rayos solares (principalmente rayos ultravioleta) con diferente intensidad de brillo. Al estar expuestas a la intemperie las tuberías deberán estar protegidas de la radiación solar para extender su vida útil.